

PowerLine

Lithium-ion Batteries

Powerline ICR18650 2200mAh

Li-ion Cylindrical Battery

Size: 18650

Typical Characteristics

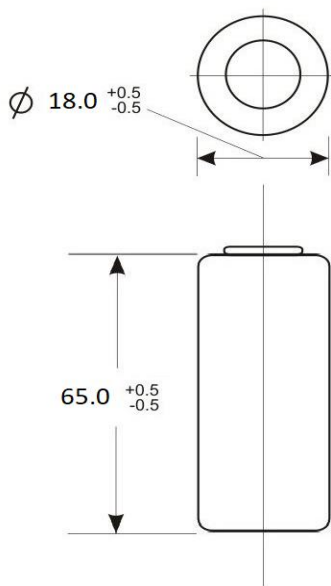

Powerline ICR18650 2200mAh			
Specifications			
Nominal Voltage (V)		3.6V	
Capacity	Discharge rate	C/5	1C
	Nominal (mAh)	2150	2070
	Typical (mAh)	2200	2120
Dimension	Diameter (mm)	18.0 ^{+0.5} / _{-0.5}	
	Height (mm)	65.0 ^{+0.5} / _{-0.5}	
Charging	Standard	220 mA x 15 hrs	
	Quick	2200 mA x 1.2 hrs T _{max} =45°C -ΔV = 5~8mV	
Operating Temperature (°C)	Standard Charging	0 ~ 45°C	
	Quick Charging	10 ~ 40°C	
	Discharging	-20 ~ 60°C	
	Storage	-20 ~ 35°C	
Internal Resistance		≤52m Ohm (upon 50% discharge)	
Weight		Approx.48g	
Cuff-off Voltage (V)		2.8	

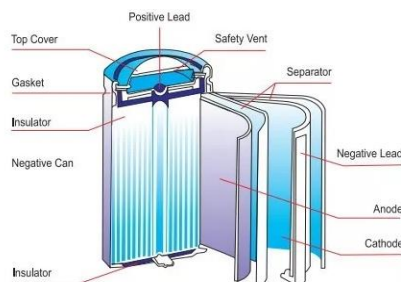
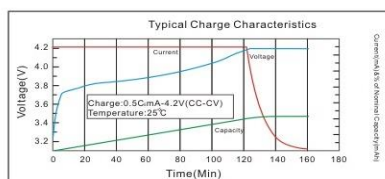
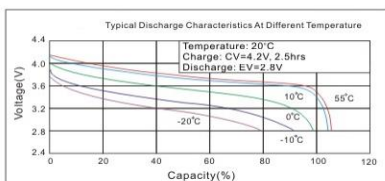
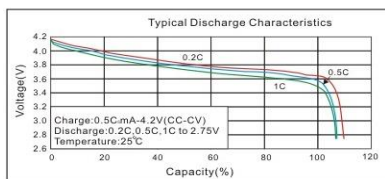

Cylindrical

The data shown is correct at a temperature of 20±5°C Shutdown at-ΔV= 15mV, after reaching 120% of the rated capacity or at a temperature above 55°C