

コイン形二酸化マンガンリチウム電池  
Coin manganese dioxide lithium batteries

# CR2477W

■外形寸法 Dimensions

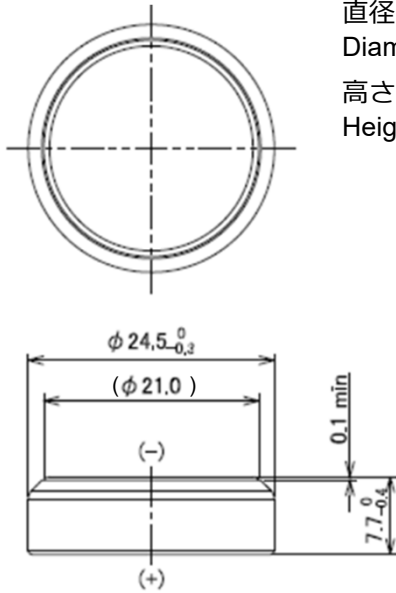

直径 : 24.5  
Diameter  
高さ : 7.7  
Height

(Unit : mm)

■定格 Specifications

公称電圧 Nominal Voltage	3.0 V
公称容量 (終止電圧2.0V) Nominal Capacity (2.0V cutoff)	1000 mAh
推奨連続放電電流値 (容量利用率高) Recommended Continuous Discharge Current (High capacity usage rate)	≤1 mA
標準質量 Weight	11 g
使用温度範囲 Operating Temperature	-40 ~ +125°C
UL認定合格部品 UL Recognized components	
<ul style="list-style-type: none"> <li>● 許可番号 Certification number : MH12566</li> <li>● User replaceable</li> </ul>	

■放電特性

Discharge Characteristics

Test Condition: constant discharge

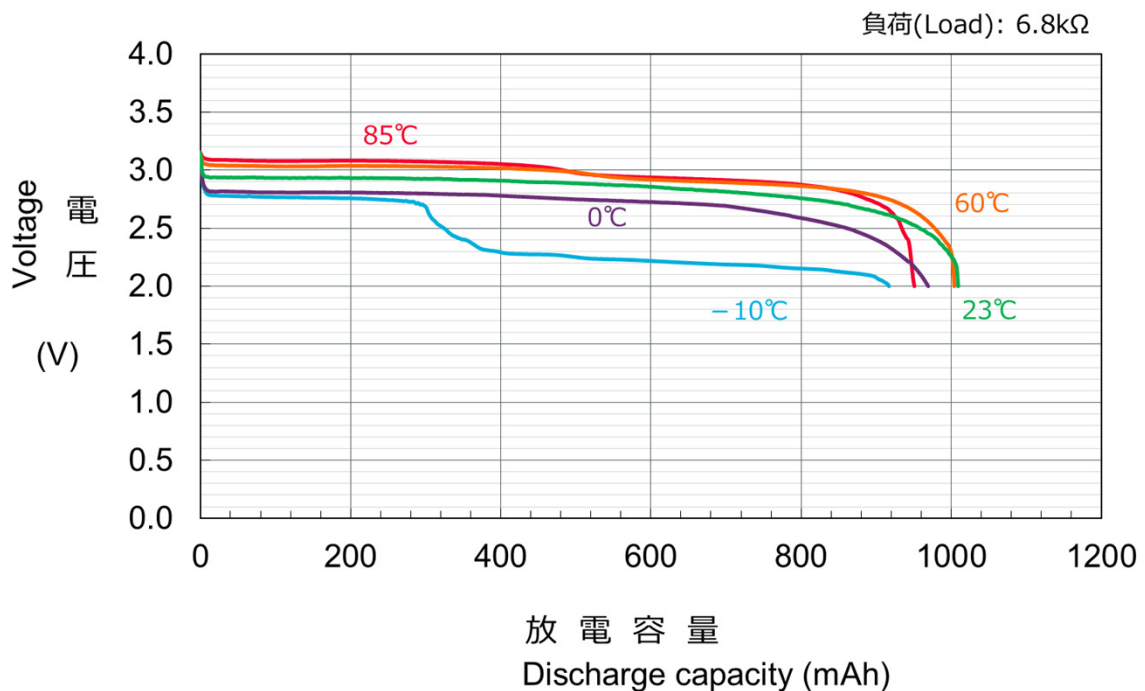

■ 放電負荷特性

Discharge Characteristics by Load  
Test Condition: constant discharge

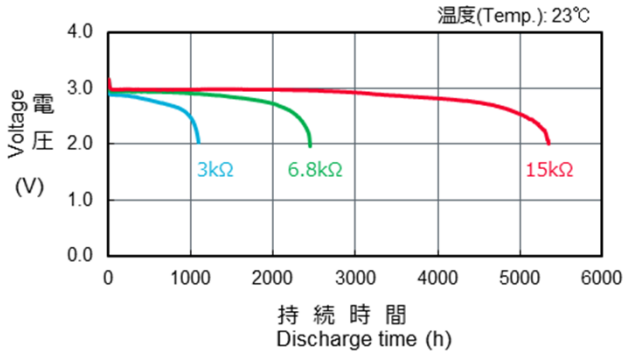

■ 放電温度特性

Discharge Characteristics by Temperature  
Test Condition: constant discharge

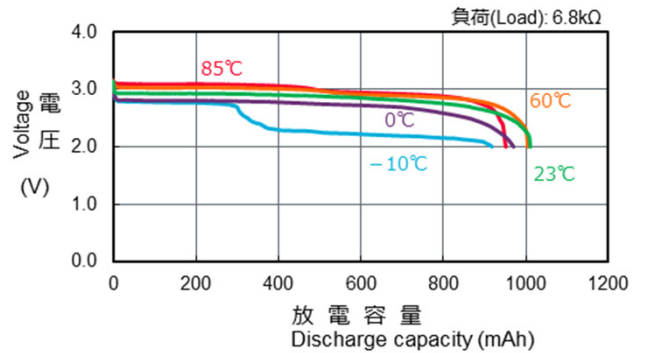

■ 閉路放電特性

Closed Circuit Voltage by Temperature

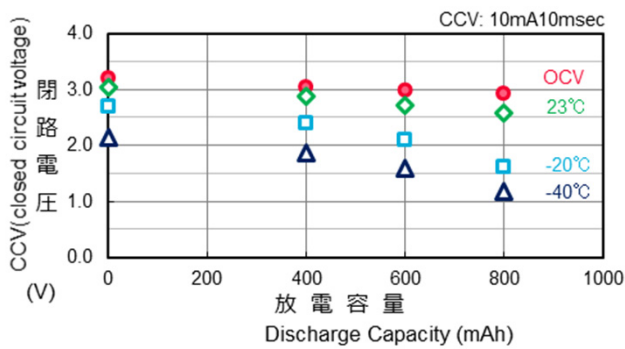

■ 内部抵抗

Impedance by Temperature

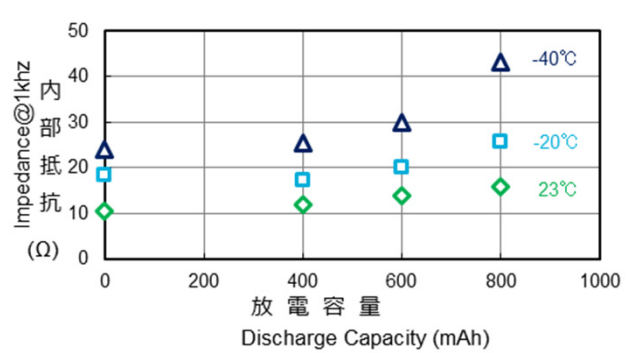

試験方法 / Test method

未放電の電池と規定の容量(400mAh,600mAh,800mAh @23°C,3kΩ)まで放電させた電池を10mA×10msec(1パルス)の条件で測定した際の電圧値。

Voltage when the Non-discharged battery and the battery discharged to the specific capacity(400mAh,600mAh,800mAh @23°C,3kΩ) is measured under the condition of 10mA × 10msec (1 pulse).

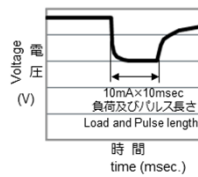

■ 自己放電特性

Self Discharge Characteristic by Temperature

注: 20°C未満の自己放電率は20°Cと同じ自己放電率になります。  
Note: The self-discharge rate of less than 20°C shows the same self-discharge rate as 20°C.

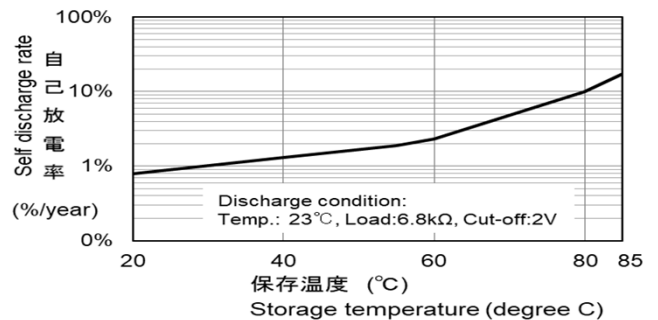

\*記載のデータ及び数値は、参考値であり保証値ではありません。

\*Data is not guaranteed, and is provided for reference purposes only.