

コイン形二酸化マンガンリチウム電池  
Coin manganese dioxide lithium batteries

# CR2430

■外形寸法 Dimensions

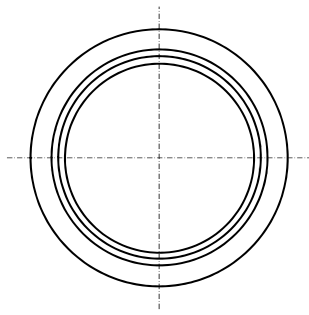

直径 : 24.5  
Diameter  
高さ : 3.0  
Height

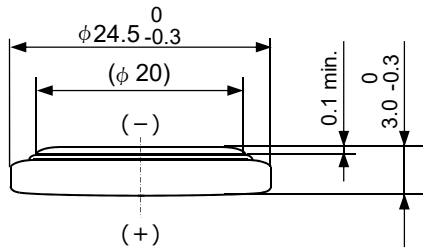

(Unit : mm)

■定格 Specifications

公称電圧 <b>Nominal Voltage</b>	3.0 V
公称容量 (終止電圧2.0V) <b>Nominal Capacity ( 2.0V cutoff)</b>	300 mAh
標準放電電流値 <b>Standard Discharge Current</b>	0.2 mA
標準質量 <b>Weight</b>	4.4 g
使用温度範囲 <b>Operating Temperature</b>	-30 ~ +70°C
UL認定合格部品 <b>UL Recognized components</b> ● 許可番号 <b>Certification number</b> : MH12566 ● User replaceable	

■放電特性

Discharge Characteristics

Test Condition: constant discharge

温度(Temp.): 23°C

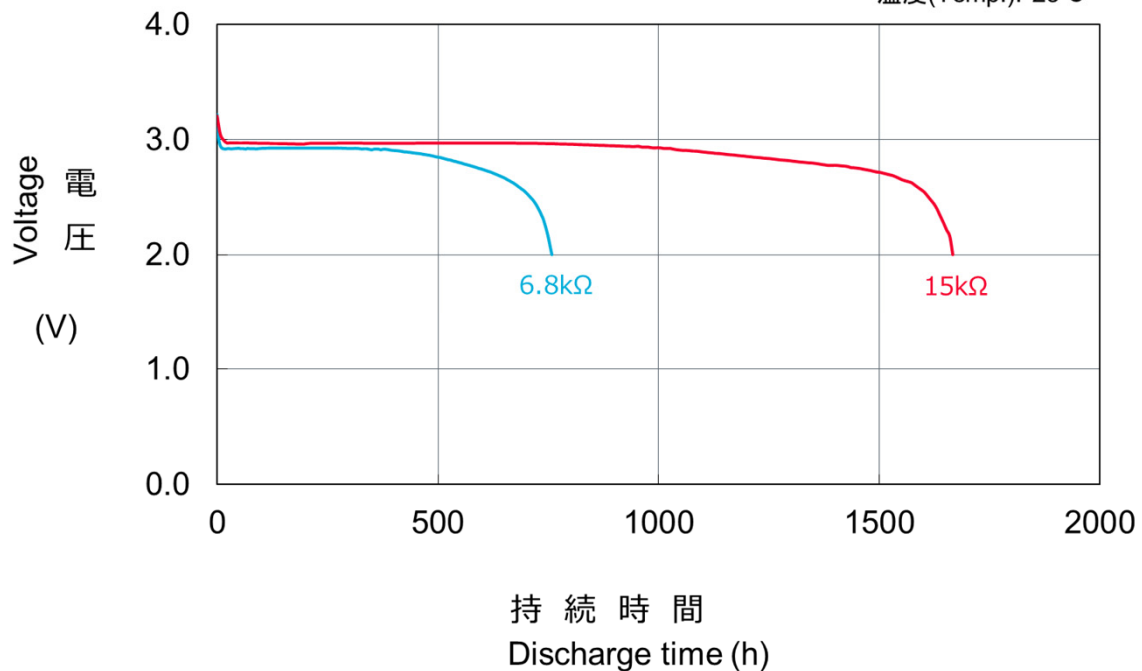

■ 放電負荷特性

Discharge Characteristics on Load  
Test Condition: constant discharge

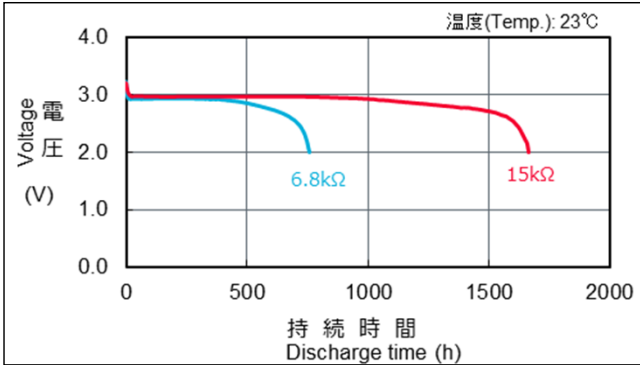

■ 放電温度特性

Discharge Characteristics on Temperature  
Test Condition: constant discharge

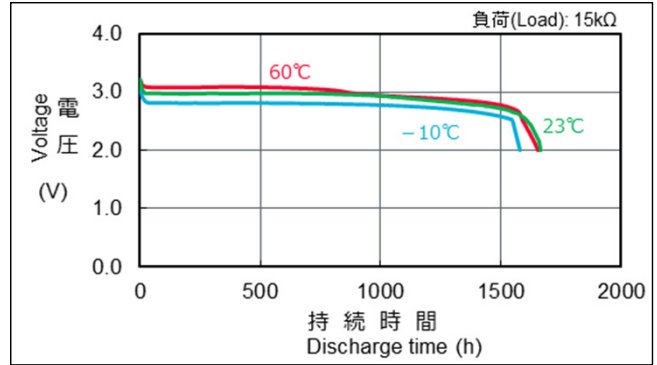

■ 放電負荷と作動電圧 (放電深度40%時の電圧)

Discharge Load vs. Operation Voltage  
(Discharge depth 40%)

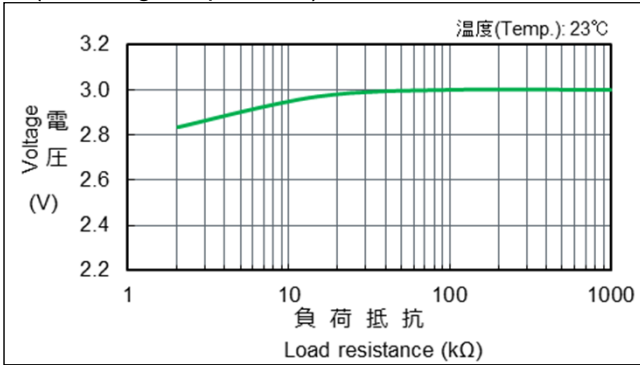

■ 放電負荷と電気容量

Discharge Load vs. Discharge Capacity

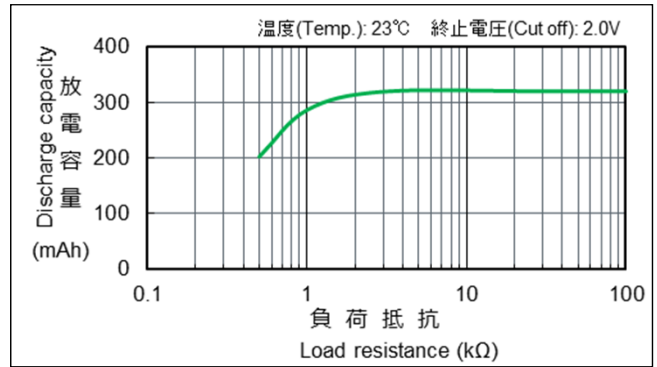

■ パルス放電特性 (放電深度40%時のパルス電圧)

Discharge Characteristics on Pulse Load  
(Discharge depth 40%)

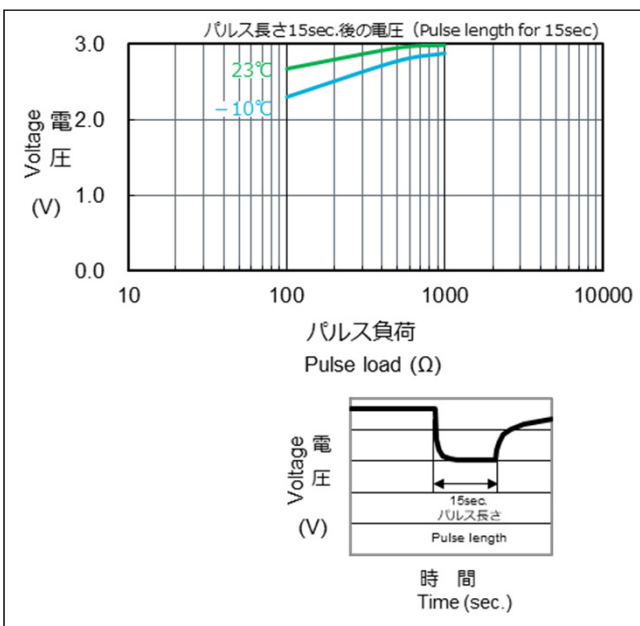

■ 保存特性

Storage Characteristics  
Test Condition: constant discharge

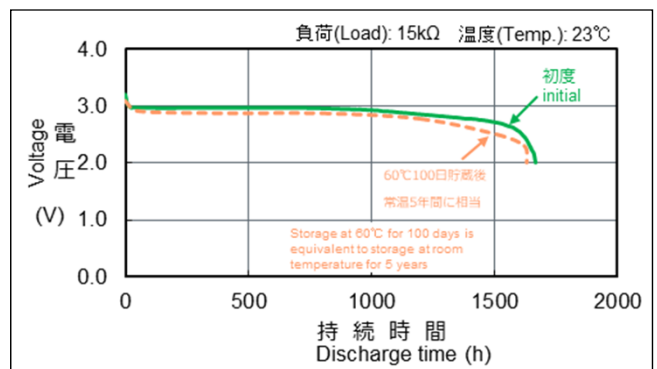

\*記載のデータ及び数値は、参考値であり保証値ではありません。

\*Data is not guaranteed, and is provided for reference purposes only.