

コイン形二酸化マンガンリチウム電池
Coin manganese dioxide lithium batteries

CR1220

■外形寸法 Dimensions

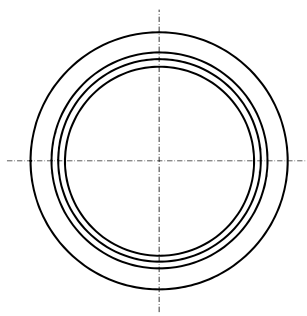

直径 : 12.5
Diameter
高さ : 2.0
Height

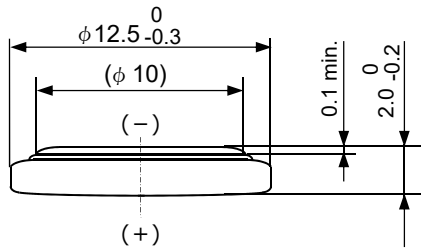

(Unit : mm)

■定格 Specifications

公称電圧 Nominal Voltage	3.0 V
公称容量 (終止電圧2.0V) Nominal Capacity (2.0V cutoff)	40 mAh
標準放電電流値 Standard Discharge Current	0.1 mA
標準質量 Weight	0.77 g
使用温度範囲 Operating Temperature	-30 ~ +70°C
UL認定合格部品 UL Recognized components ● 許可番号 Certification number : MH12566 ● User replaceable	

■放電特性

Discharge Characteristics

Test Condition: constant discharge

温度(Temp.): 23°C

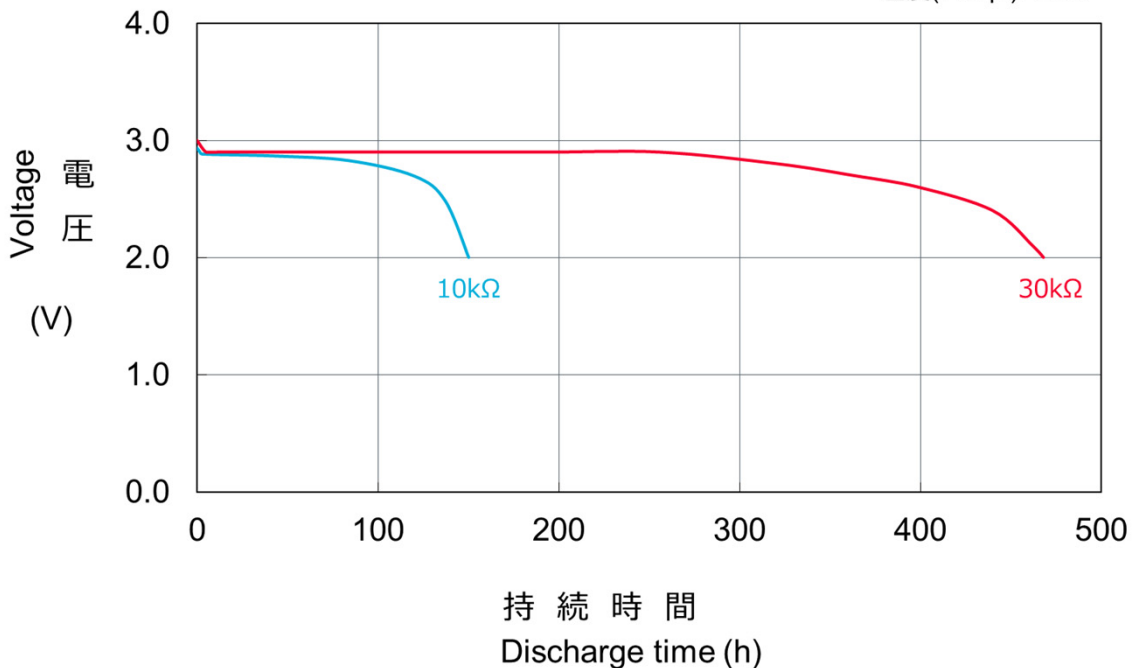

■ 放電負荷特性

Discharge Characteristics on Load
Test Condition: constant discharge

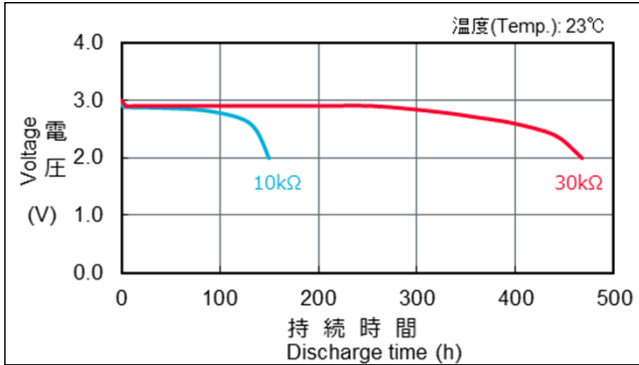

■ 放電温度特性

Discharge Characteristics on Temperature
Test Condition: constant discharge

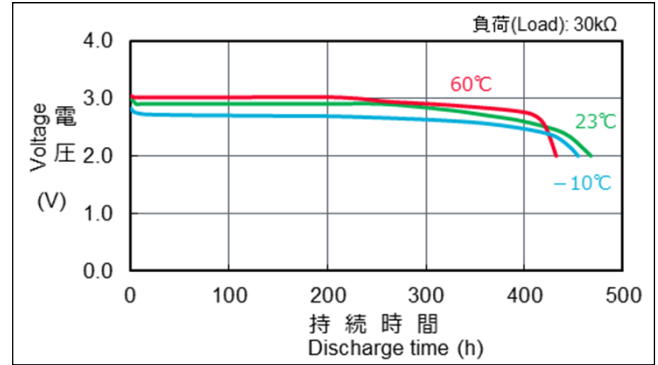

■ 放電負荷と作動電圧 (放電深度40%時の電圧)

Discharge Load vs. Operation Voltage
(Discharge depth 40%)

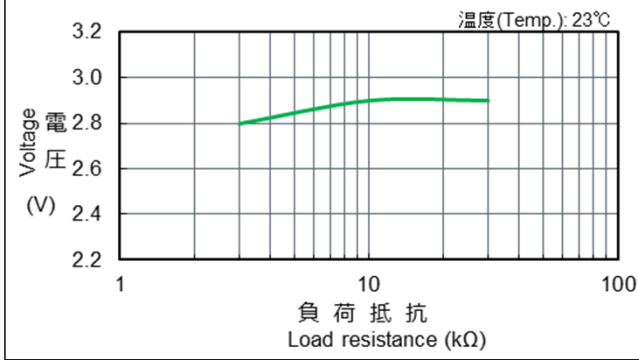

■ 放電負荷と電気容量

Discharge Load vs. Discharge Capacity

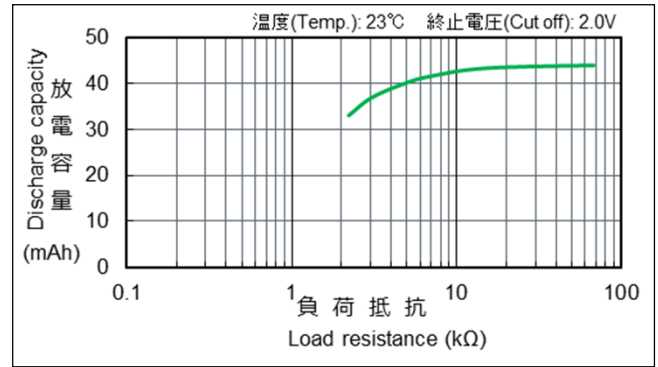

■ パルス放電特性 (放電深度40%時のパルス電圧)

Discharge Characteristics on Pulse Load
(Discharge depth 40%)

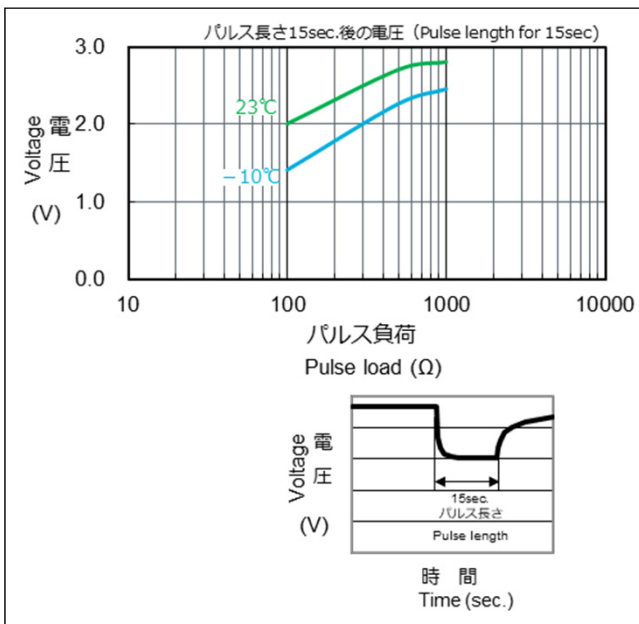

■ 保存特性

Storage Characteristics
Test Condition: constant discharge

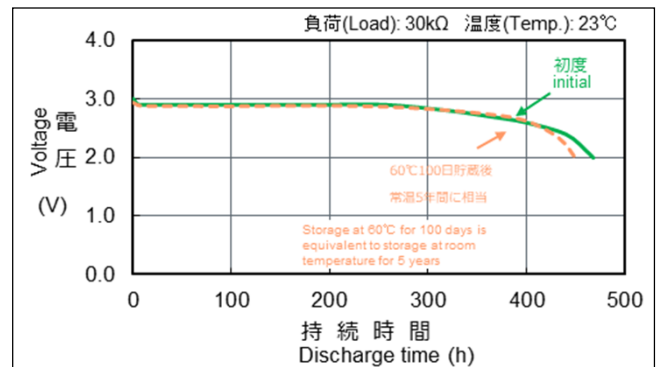

*記載のデータ及び数値は、参考値であり保証値ではありません。

*Data is not guaranteed, and is provided for reference purposes only.